

---

## Stimulation of the Acoustico-Lateralis System of Clupeid Fish by External Sources and their Own Movements

E. J. Denton and J. A. B. Gray

*Phil. Trans. R. Soc. Lond. B* 1993 **341**, 113-127  
doi: 10.1098/rstb.1993.0096

---

### Email alerting service

Receive free email alerts when new articles cite this article - sign up in the box at the top right-hand corner of the article or click [here](#)

---

To subscribe to *Phil. Trans. R. Soc. Lond. B* go to: <http://rstb.royalsocietypublishing.org/subscriptions>

---

# Stimulation of the acoustico-lateralis system of clupeid fish by external sources and their own movements

E. J. DENTON AND J. A. B. GRAY

*Marine Biological Association of the United Kingdom, The Laboratory, Citadel Hill, Plymouth PL1 2PB, U.K.*

## SUMMARY

1. The receptor organs of the acoustico-lateralis system in fish respond in various ways to pressures and pressure gradients and provide the fish with information about external sources of vibration.

2. A fish's movements will set up pressures and pressure gradients and this poses three questions. (i) Can a fish obtain useful information from self-generated pressures and pressure gradients? (ii) To what extent do self-generated pressures mask signals from external sources? (iii) Can interactions between external and self-generated pressures and gradients in the acoustico-lateralis system give patterns of activity from the receptor organs which have special significance?

3. In herring (*Clupea harengus* L.) and sprat (*Sprattus sprattus* (L.)) measurements have been made of dimensions of various parts of the acoustico-lateralis system particularly of the subcerebral perilymph canal which crosses the head between the lateral lines.

4. Self-generated pressures produced by lateral movements of the head are antisymmetric, i.e. equal and opposite in sign on the left and right sides of the head. They oppose the accelerations of the head that produce them. In contrast, external sources give pressures that are largely symmetric. Any pressure gradients they give will accelerate the fish and the surrounding water together and any net pressure gradients will be small and so will any flows through the subcerebral perilymph canal.

5. Flows of liquid between the lateral lines across the lateral-recess membranes have been measured at various frequencies for pressure gradients applied across the head. Between 5 and 200 Hz the velocity of flow per unit pressure does not vary by more than a factor of 2. At low frequencies the absolute values of flow are very much larger (more than 50 times) than those found for equally large symmetrically applied pressures (as from an external source) due to flow into the elastic gas containing bullae.

6. It is calculated that a net pressure difference (at optimum frequency) across the head of only 0.008 Pa will reach threshold for the lateral line neuromast nearest the lateral recess and one of 0.02 Pa for that under the eye. The responses of these neuromasts are expected to saturate and provide little information when the pressure differences across the head exceed 6 to 18 Pa. The pressures given by the swimming fish are discussed in the light of a theory advanced by Lighthill in the paper that follows this paper. With such antisymmetric pressures the direction of flow in the lateral-line canals will be towards the lateral recess on one side of the fish and away on the other and so differ from the situation found with an external source when flow at any instant will be either towards or away from the lateral recess on both sides of the head.

7. Antisymmetric pressures can produce large flows past the utricular maculae. However, at low frequencies flows across the maculae, on which their stimulation depends, will be small. We do not know the direction of these latter flows though they will be in opposite sense on the two sides of the head, again unlike the situation with an external source.

8. Calculations of impedances below 30 Hz show that the observed flows across the head are consistent with the dimensions and properties of the known structures.

9. There are major and systematic differences in the patterns of receptor organ stimulation between those expected from external sources and from a fish's own movements.

10. Experiments on the red mullet (*Mullus surmuletus* L.) showed that it too has a transverse channel connecting the right and left lateral-line systems. At low frequencies its properties resemble those of the subcerebral perilymph canal of the clupeid.

## 1. INTRODUCTION

It is generally agreed that the acoustico-lateralis systems of fish give useful information about the

positions and natures of neighbouring sources of vibrations or changes in the pattern of pressures around a fish produced by obstacles (see, for example, Weissert & von Campenhausen 1981; Blaxter & Batty

1985; Enger *et al.* 1989; Hassan 1989; Montgomery 1989; Blaxter & Fuiman 1990). For a fish like the herring the largest pressures and pressure gradients to which these receptor organs will be exposed in life are probably those coming from the fish's own movements; herring swim continuously since they are denser than seawater.

In this paper we do not deal with the steady or very slow changing self-generated pressure fields that are symmetric around the long axis of a fish, e.g. those found in a gliding fish or presumably in paired fin locomotion. We deal with changing self-generated fields which are antisymmetric arising from side slip and yawing motions of the head. This is not because pressures found in gliding motion are negligible. We would expect the stagnation pressure on the snout of a fish gliding with a velocity of  $0.3 \text{ m s}^{-1}$  to be about 50 Pa (see Du Bois *et al.* 1974). However we would expect these symmetrical pressures to fall to small values at positions corresponding to the lateral recesses of clupeids between which are the flows in the subcerebral canals that excite both the utricular maculae and certain neuromasts in the lateral line canal. Furthermore at low frequencies, in fish like the herring, such symmetrical pressures will be only about 1/50th as effective in stimulating these neuromasts as antisymmetrical pressures produced by lateral movement of the head.

Three interesting questions arise from this.

1. How can such a fish obtain useful information from the stimuli arising from external sources against the background of stimuli produced by its own movements?

2. Can such a fish obtain useful information about its own movements and the reaction of the medium to these movements from the responses of its acoustico-lateralis system?

3. Can such a fish, in order to make rapid responses with minimal delays in the brain, make use of particular patterns of nerve impulses arising from interactions at a physical level between the pressures and pressure gradients produced by external sources and those given by its own movements? This could be advantageous, e.g. in reacting sensibly to a rapid Mauthner turn by a neighbour or in modifying its swimming movements to take advantage of the disturbances produced by the fishes ahead of it in a school.

The experiments described in this paper cannot answer these questions directly but are an attempt to establish for two fish, the herring (*Clupea harengus* L.) and the sprat (*Sprattus sprattus* (L.)) certain basic facts about the responses of lateral-line neuromasts and of the maculae of the utricular recess to pressure gradients across the head, of the kind which would be generated by its own movements. Previous papers have reported on the likely responses of these organs to pressures and pressure gradients from external sources (Blaxter *et al.* 1981; Gray 1984).

In considering the questions raised above let us first compare the nature of the stimuli from external and self-generated sources of vibration. These differ in at least three ways.

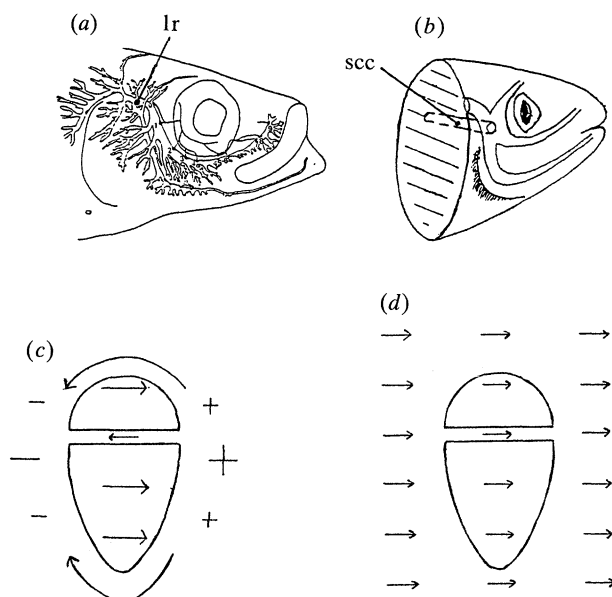

Figure 1. Diagram to illustrate pressures and accelerations related to a fish's own movement and to an external source of vibration. (a) Lateral view of a clupeid head to show position of lateral line. The black spots in the main canals give positions of neuromasts; lr, lateral recess. (b) Perspective sketch to illustrate position of subcerebral canal in relation to the lateral line; scc, subcerebral canal. (c) Cross section of fish: changes due to fish's own movement; pressure + or -; arrows indicate accelerations (not displacements). (d) Changes due to an external source (not shown in diagram) on left hand side of the fish, symbols as (c): note, there are no relative accelerations between fish and the liquid in the subcerebral canal.

1. In general we might expect that those produced by the fish itself would be larger than those given by a neighbouring fish making similar swimming movements.

2. The self stimuli produced by lateral movements of the head will be antisymmetric, i.e. at a given position along the length of the head at any given instant the pressures on the two sides of the head will be equal but opposite in sign. In this case the accelerations of the head, which are caused by the activity of the body muscles, will produce pressure gradients in the medium that will oppose these accelerations (figure 1c). We distinguish between the accelerations attributable to the side-slip movements of the head and those arising from the yawing movements of the head whilst the fish has a forward velocity in the medium (see Lighthill 1993).

3. The pressures produced by an external source will, unless the source is very close, be mostly symmetric. In so far as external sources produce pressure gradients across the head these will accelerate the head with the pressure gradient (figure 1d).

The acoustico-lateralis system of the clupeid is unusual in several respects. Allen *et al.* (1976), Gray & Denton (1979), Best & Gray (1980) and Denton & Gray (1980) refer to earlier work and give accounts of the anatomy and some of the mechanical and nervous responses to stimulation by sources external to the fish.

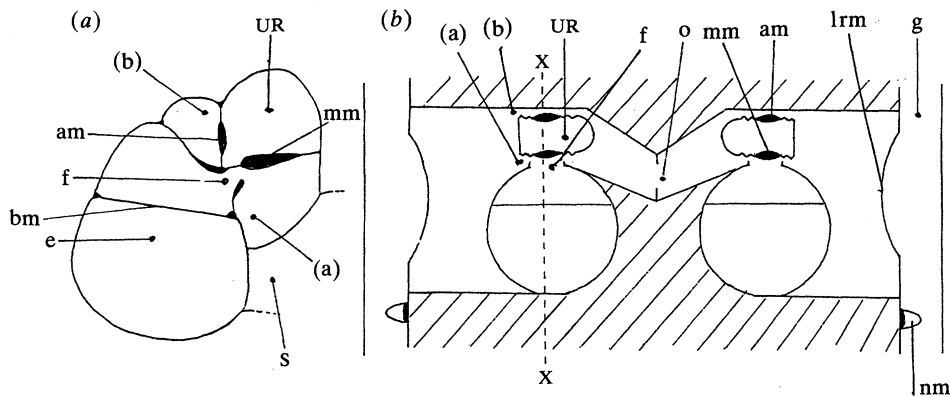

Figure 2. (a) Sketch of longitudinal section through part of the bulla and labyrinth of a clupeid (Gray & Denton 1979, figure 5; Best & Gray 1980, figure 2). (a), Subcerebral canal, channel (a); (b), subcerebral canal, channel (b); UR, utricular recess; S, sacculus; e, gas space beneath the membrane in the bulla; f, the fenestra of the bulla; mm, middle macula of the utricular recess; am, anterior macula of the utricular recess; bm, bulla membrane. (b) Diagram of channels across the head. These are in different planes (see (a)) but are here shown diagrammatically in a single plane. Symbols as (a) plus: lrm, lateral-recess membrane; o, opening in mid-line membrane; g, lateral-line canal; nm, lateral-line neuromast. If there is a pressure gradient between the lateral-recess membranes (i.e. across the head) the flow of liquid resulting from an alternating pressure will pass along channels (a) and (b); some may pass through mm and am, which have elastic suspensions, between (a) and (b). With pressure changes there can also be flows into and out of the bulla due to the expansion or contraction of the gas at e. The dashed line X-X indicates the position in this diagram of a section such as figure 1a.

Figures 1 and 2 show the relations between some of the main components of the acoustico-lateralis system of a clupeid fish. The lateral line, which is only found on the head, is centred on the lateral recess. A compliant membrane, the lateral recess membrane, separates the sea water in the lateral-line canals from the perilymph of the auditory system. The spaces immediately inside the lateral recess membranes are connected by a canal system which we shall call the subcerebral canal (this system includes both the utricular and saccular subcerebral-canals of Tracy (1920)). The auditory system has two types of receptor organs: (i) the otolith organs which primarily detect accelerations of the head; and (ii) the receptor organs associated with the auditory bullae which primarily detect pressure changes. Lateral-line neuromasts generally detect net pressure gradients between openings in the lateral-line canals (i.e. when account has been taken of the movements of the fish). However, in the clupeids these neuromasts also respond to pressure changes. This is because flows of liquid into and out of the auditory bullae, caused by pressure changes acting on the gas which the bullae contain, pass across the lateral-recess membranes and along the lateral-line canals.

If identical (symmetrical) pressure changes are applied to both sides of the head there will be no flows of liquid across the head and the volume displacements of the bulla membranes and the lateral recess membranes will be almost identical. On the other hand, if asymmetric or antisymmetric pressure changes are applied between the two sides of a stationary clupeid head we might expect, from its anatomy, that liquid would flow across the head mainly through the subcerebral perilymph canal as well as into and out of the auditory bullae. At very low frequencies we would expect that the absolute

volume displacements of the lateral-recess membranes would be many times greater than the volume displacements of the bulla membranes. This is because the lateral-recess membranes are known to be much less stiff than the bulla membranes. We should also expect this to be the case when antisymmetric pressures are given by the fish's own movements. However, if asymmetric pressure changes are produced by an external source, then, since the head and the sea water close to the head will be accelerated in almost the same way, the net flows through the subcerebral canal will be relatively small. All this suggests that the patterns of stimulation given to the various receptor organs of the acoustico-lateralis system by self-generated and external sources will be different from each other. In this paper we attempt to quantify some of these differences.

The plan of research involved three steps.

1. To measure, over a range of frequencies, the flows of liquid through the head between the two lateral recesses that are given by pressures applied to one side of the head.

2. From a knowledge of the thresholds and working ranges of neuromasts in the lateral line canals (Gray 1984) to calculate the pressure differences across the head that would be required for threshold and saturation of some neuromasts. Next to compare these values for asymmetric pressure across the head with those for symmetrical pressures and also with those for net pressure gradients along the canals.

3. To consider the stimulation of the anterior and middle maculae of the utricular recess (figure 2) by the pressure changes produced by external sources and by the fish's own movements.

The experimental programme was supported by calculations based on models and on the calculation of



resistances and inertances from the dimensions of the relevant anatomical structures.

## 2. METHODS

### (a) Material

The experimental work was done on herring (*Clupea harengus* L.) of standard lengths from 10 to 14 cm. They were freshly killed by placing in a bucket containing a suitable solution of 2-methylbutan-2-ol (tertiary-amyl alcohol) until gilling and reflexes had ceased. To avoid any error the water in the experimental bath contained the anaesthetic. In some cases the lateral-line canals lying over both lateral recesses were removed and, on at least one side, so was the bony plate with a small opening that lies between the canal and the lateral recess membrane (Gray & Denton 1979, figure 7) thus exposing the whole lateral-recess membrane.

The morphological work involved some dissection of fresh fish but mainly involved making new measurements on old material. This included two sets of stereo-photographs of heads mounted in resin, ground down, polished and photographed in 20 µm steps (Best 1979). One set was that of a head of a herring ground at right angles to the long axis of the fish (Gray & Denton 1979, figure 4) and the other a set of the head of a sprat (*Sprattus sprattus* (L.)) ground longitudinally (Gray & Denton 1979, figure 5). We also used a set of stained longitudinal sections, 20 µm thick, of a sprat head (Best & Gray 1980).

Some preliminary morphological and experimental observations were made on red mullet (*Mullus surmuletus* L.).

### (b) Apparatus

Figure 3 is a diagram of the apparatus which was used to measure particle movements in the lateral line and displacements of lateral-recess membranes to

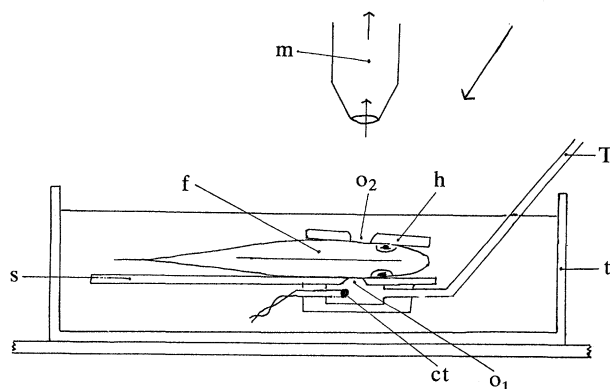

Figure 3. Diagram of apparatus used to measure displacements of the lateral recess membrane and of particles in the lateral line canals. t, tank; f, fish; s, stage; h, holding plate; m, microscope and photomultiplier; ct, ceramic transducer; o<sub>1</sub>, opening on top of pressure chamber; o<sub>2</sub>, opening in holding plate; T, tube leading to source of varying pressure. DC transducer not shown in the diagram.

asymmetric pressures. It was made mostly of Perspex. The fish (f) was laid on a stage (s) and held in position by a plate (h) controlled by three bolts. The whole stage was in a tank (t) filled with sea-water and was held at both ends by pivots so that the stage and fish could be rotated through 360°. The fish was positioned so that the lateral recess on one side was on the opening (o<sub>1</sub>) and the plate holding the fish adjusted so that another opening (o<sub>2</sub>) was over the other lateral recess. The part under the lower lateral recess is the pressure chamber connected to a source of pressure by tube (T) and to two transducers for recording pressure (only one of which is shown).

### (c) Pressure sources

The usual source of pressure was an electromagnetic vibrator (Derritron VP2) which had a plunger operating in air (see figure 1 of Denton & Gray 1980). The pressure was transmitted to water at an interface in the connecting tube (T). This interface was kept at the level of the water surface in the tank so that there was no standing pressure across the fish's head. The vibrator was driven by electrical systems which could give bursts of sine waves whose start could be precisely timed allowing superposition or averaging of the records. Sometimes sweeps in which frequency rose continuously from a predetermined start frequency to a known end frequency were used. Step functions of pressure were also used, the connecting tube being opened via taps either to a source of raised or lowered pressure or to atmospheric pressure.

### (d) Pressure recording

Two systems were used in parallel. A ceramic cylindrical transducer (ct in figure 3) was placed in the pressure chamber. The frequency response was flat down to 5 Hz and, with corrections, could be used down to about 2 Hz. There were no problems at higher frequencies and its sensitivity was 11 µV Pa<sup>-1</sup>. We also used a DC transducer. This was a strain gauge/bridge system, the Bell and Howell 'Physiological Pressure Transducer'. This recording system was bulky and had to be connected to the pressure chamber by a tube. This connection severely limited the usefulness of the transducer at frequencies above 10 Hz. The sensitivity was 0.25 µV Pa<sup>-1</sup>.

### (e) Biological recording

Two methods were used. If a suspension of 20 µm latex spheres is dropped on the outside of the lateral-line canal, the spheres rapidly enter the canal. These or natural debris were viewed with a dissecting microscope fitted with a micrometer eyepiece and the length of the lines produced when they were made to vibrate at different frequencies measured. The second method was to record changes in the reflected light coming from the highly reflective lateral recess membrane when it was displaced. An image of part of the lateral-recess membrane was formed by a microscope onto a small aperture and the light passing through

this aperture was recorded with a photomultiplier (see Denton *et al.* 1979).

(f) *Permanent records*

The electrical records from transducers and photomultiplier were stored on magnetic tape, and then printed out for measurement with a pen writer (often after averaging a series of traces).

### 3. RESULTS

(a) *Observations on particle movements*

A number of measurements were made of the displacements of particles or debris in the lateral lines when either sinusoidal or step pressure changes were applied to one side of the head. In a preliminary experiment it was found that such asymmetric pressures produced displacements of debris in the lateral line canals that were at least 20 times greater than those given by symmetric pressures in experiments made with the apparatus described by Gray & Denton (1979, figure 2). Three experiments were made in which the displacement of (20  $\mu\text{m}$  diameter) latex spheres introduced into the lateral line system were measured in the infra-orbital canal close to the lateral recess.

This canal was opened completely at a distance of a few millimetres from the lateral recess so ensuring that most of the flow passing through the lateral recess also passed through this particular canal. Measurements were made, over a range of frequencies, of the displacements produced by sinusoidal pressure changes applied to the opposite side of the head from that on which the observations were made. In figure 4 we show the results graphically, plotting displacement divided by pressure against frequency. All three experiments show a range of lower frequencies over which this function is almost constant followed, as frequency increases, by a progressive decline in the

displacements produced by a given pressure. On this graph the value of displacement divided by pressure at zero frequency has been made equal to one. The absolute displacements for frequencies of around 2 to 5 Hz were for the three experiments 3.3, 0.6 and 2.0  $\mu\text{m Pa}^{-1}$ . In the last of these experiments, which was technically the most satisfactory, to estimate flows the cross-sectional dimensions of the infra-orbital canal were measured close to the position where observations on particles had been made.

The canal was approximately elliptical in shape, its wider dimension being about three times greater than its narrower and its cross-sectional area was about 0.5  $\text{mm}^2$ . Now the displacements of particles were measured in the centre of the canal. Because, at frequencies around 2 to 5 Hz, the pattern of displacement would have been roughly parabolic across the cross-section of the canal the mean displacements in the canal would have been about one half of those measured, i.e. about 1  $\mu\text{m Pa}^{-1}$ . We estimate that at these low frequencies the total volume displacements, taken as the products of mean displacements and cross sectional area, along the opened infra-orbital canal must have been about  $5 \times 10^{-13} \text{ m}^3 \text{ Pa}^{-1}$ . To obtain the flow (volume velocity) this value was multiplied by  $2\pi \times$  frequency.

(b) *Observations made with light reflected from the lateral recess membrane*

Although measurements of light reflected from the lateral recess membrane with the apparatus shown in figure 3 cannot give absolute values of flows of liquid through the lateral recess they have the merits of being of higher precision and usable over a much greater range of frequencies than those made by microscopic measurements of particle movements.

For all the frequencies used the output of the photomultiplier was proportional to the displacements of the membrane (figure 5). A typical result giving relative displacement against frequency is shown in

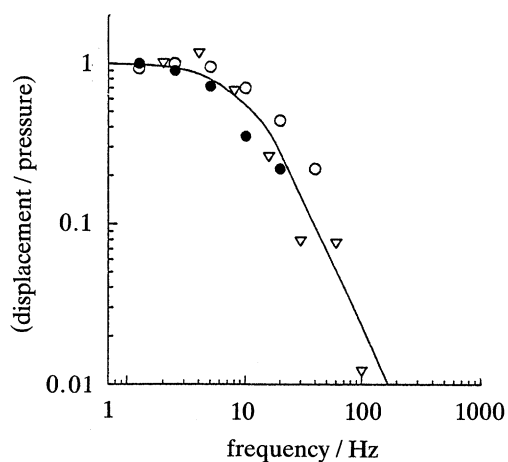

Figure 4. Displacement of particles divided by pressure (making this equal to unity at very low frequencies) plotted against frequency; log-log plot. Symbols for three experiments; the curve is that fitted to figure 6 (see text).

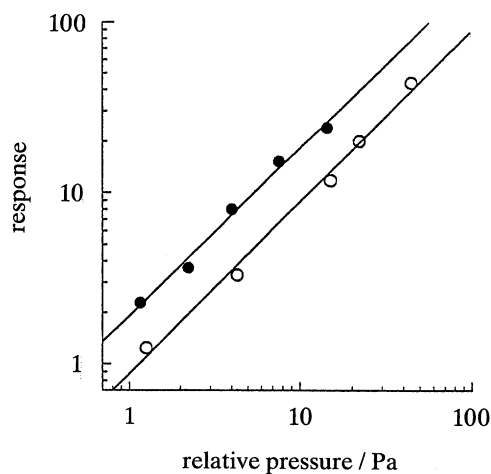

Figure 5. Linearity of optical recording system. Abscissa, pressure; ordinate, response amplitude. Two runs on different preparations, open circles at 12 Hz, filled circles at 60 Hz.

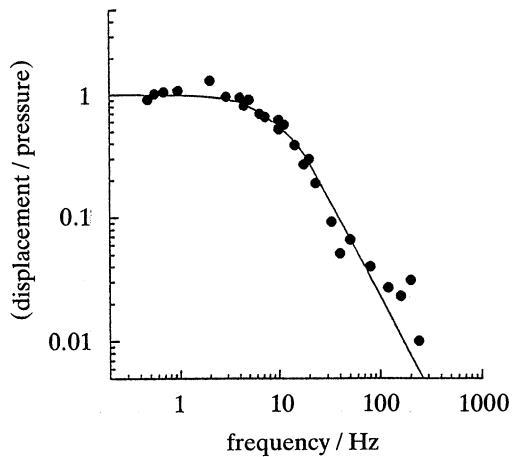

Figure 6. Relative displacements measured from reflections from the lateral recess membrane plotted against frequency; log-log plot. Abscissa, frequency (Hz); ordinate, relative displacement per unit pressure (displacement at zero frequency made equal to 1). The curve is the best fit with quantities derived from the experimental points and assuming a simple network as in figure 11 (see text). The values are in column 2 of table 3. Same experiment as one curve in figure 8.

figure 6 where, as the ranges in both axes are large, a log-log plot is used. The ordinate is scaled so that displacement of the lateral recess membrane is taken as unity at zero frequency, i.e. when only the stiffness of the membrane contributes to the impedance. The line on this figure is discussed below.

The experiment shown in figure 6 and most of the other experiments were made after removal of the lateral-line canals and the bony layer which lies external to the lateral recess membrane (Gray & Denton 1979, figure 7). This gave better and more stable reflections. The removal of the impedance external to the membrane made little if any difference. The results of two early experiments, one with the exterior structures intact and the other with them removed are shown in figure 7.

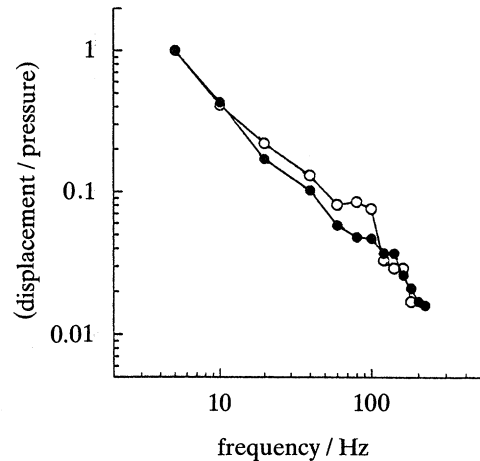

Figure 7. Similar plot to figure 6. Two experiments with displacements measured from reflections from lateral recess membranes. Open circles, lateral line removed; filled circles, undissected fish.

The neuromasts of the lateral lines of clupeids give, over the frequency range up to 80 Hz, approximately constant neural responses for given velocities of sea water in the canal independently of frequency (Denton & Gray 1989). Furthermore the values in table 1 described and discussed below derive from the relation of flow (volume velocity), rather than displacement, to pressure. We therefore show in figure 8 the results of two experiments—the one in figure 6 and one of those in figure 7—plotted as flow against pressure and, since the range of the values of flow is relatively small the plot is made linear-log. Such a plot is necessarily more sensitive to differences between experiments and the two curves are different particularly in the frequencies at which the peaks appear. In all experiments two peaks occur in such plots, one between  $< 2$  and 20 Hz and the other between 100 and 200 Hz. However the range of amplitude change, i.e. flow per unit pressure, between 5 and 200 Hz is not more than a factor about 2. This is probably not of great biological significance

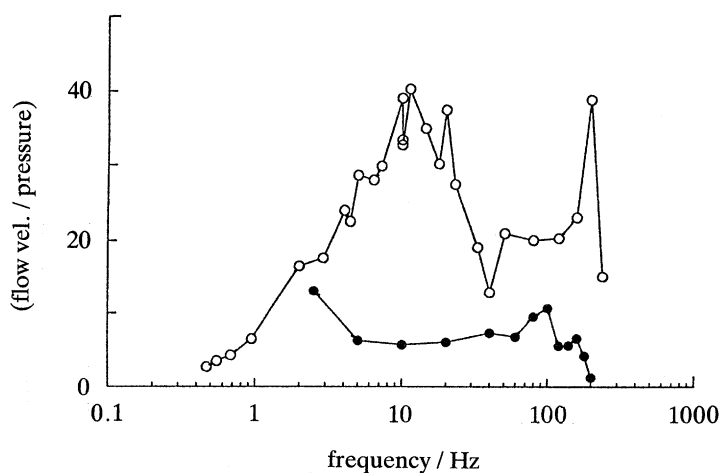

Figure 8. Plot of flow velocity against frequency; linear-log. Ordinate, flow velocity per unit pressure (amplitude standardized by taking displacement at zero frequency equal to 1). Upper line from experiment of figure 6 and lower from figure 7 (open circles).

and the flow can be considered as practically constant over this range of frequencies which is probably the important biologically range.

(c) *The subcerebral perilymph canal*

Figures 2 and 9 show diagrammatically the relations of the sub-cerebral canal to the maculae of the utricular recess and the fenestra of the auditory bulla. The anterior (am in figure 2*a*) and middle (mm in figure 2*a*) maculae are oval structures suspended on thin membranes containing some elastic tissue in openings in the walls of the utricular recess (UR in figure 2*a*). The former lies between the utricular recess and branch (b) of the subcerebral canal and the latter between the recess and branch (a) of the canal (figure 2*a*). The canal, although varying greatly in cross-sectional area and dividing into two branches where it passes the two maculae, runs the whole distance between the two lateral-recess membranes, crossing the mid-line through two channels (shown as one in the diagram (figure 2*b*)). The utricular recess is a protuberance on the anterior medial part of the utriculus, which is filled with endolymph and continuous with the semi-circular canals, the sacculus and lagena. It has been shown (Best & Gray 1980) that when the middle macula is displaced by flow into or out of the bulla the anterior macula moves in a direction that would compensate the volume change in the utricular recess. It is assumed that these volumes are equal and that the volume of the utriculus remains constant.

We wished to see if we could obtain information about possible pressure gradients across the utricular recess when there was a flow across the head due to a pressure difference between the lateral recesses. To this end we calculated the impedances in the two branches of the subcerebral canal from their dimensions. To obtain such dimensions we measured three sets of material (see § 2*a*). We required relative values and the best material for this purpose was the set of

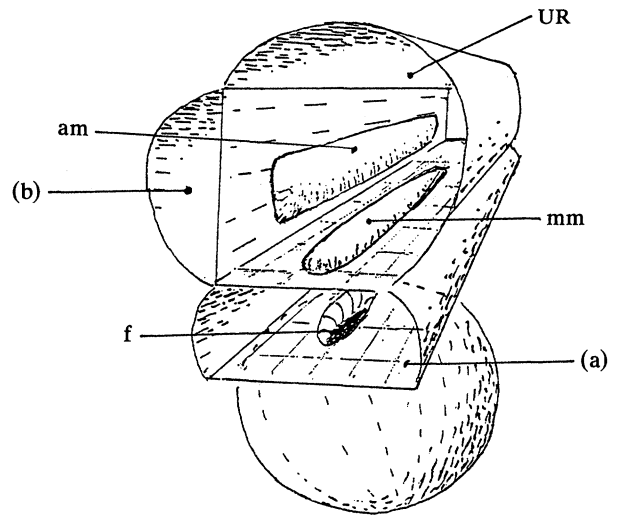

Figure 9. Perspective sketch to show relationship of channels (a) and (b) to the utricular recess and its maculae. For lettering see figure 2.

longitudinal sections of a sprat head. Areas of channels (a) and (b) were measured at 60  $\mu\text{m}$  intervals from camera-lucida tracings of the sections. Figure 10 is a plot of the areas of the subcerebral canal and its two branches against distance from the mid line.

(d) *The red mullet*

Some observations were made on the lateral-line system of the red mullet on the part of the head on which the lateral recess is found in the herring and sprat. On the red mullet, a section of lateral-line canal runs in an approximately dorso-ventral direction a few millimetres posterior to the eye. The upper end of this section arises from the place where the body lateral line joins the head lateral line. In a fish of length 22 cm, its diameter parallel to the surface of the fish was 0.6 mm. When the external wall of this

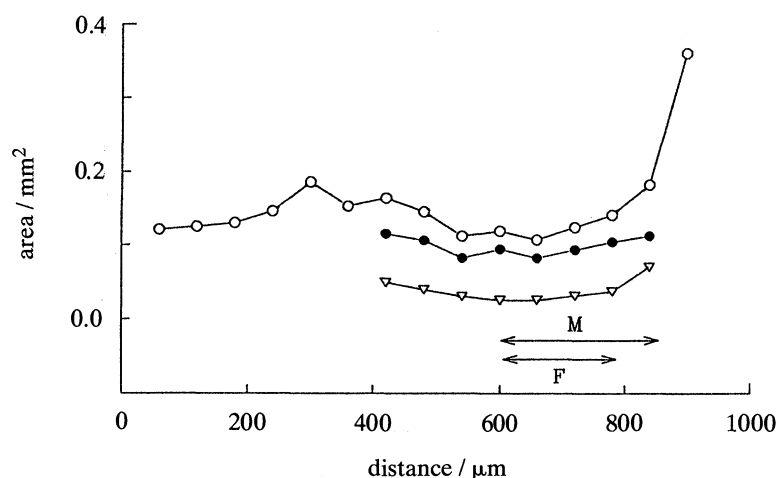

Figure 10. Sprat. Cross-sectional areas of parts of the subcerebral canal against distance from the midline. Abscissa, distance from the midline,  $\mu\text{m}$ ; ordinate, area of channels,  $\text{mm}^2$ . Open circles, total area, either that of common canal or the sum of the areas of the separate channels; filled circles, area of channel (a); triangles, area of channel (b).  $\leftarrow\text{M}\rightarrow$ , approximate position of maculae (see figure 2*b*);  $\leftarrow\text{F}\rightarrow$ , fenestra.



section of canal was removed a funnel shaped opening was seen in its inner surface near its upper end. This led to a channel running directly inwards. The opening was approximately elliptical in cross section. Its long axis, which was parallel to the length of the canal was 1.1 mm long. Its short axis was 0.5 mm long. When the canals on both sides of the head were opened and the fish laid on its side in air, drops of sea water containing a vital stain applied to the upper opening ran readily through the head and out of the lower opening on the other side of the head.

A further experiment was made on another red mullet which was 17 cm long. The external wall of the lateral line above the opening described above was removed on the left side of the fish. Pressure changes were then applied to this opening in the apparatus shown in figure 3 while observing the movements of particles (debris) in the intact lateral line on the right side of the head. With the application of sinusoidal pressure changes at a frequency of a few Hz it was easy to see that the positive pressures applied to the left side of the head caused liquid to flow out of the opening on the right side and that negative pressures caused liquid to flow into this opening. At a frequency of 2 Hz the displacements in the canal were approximately  $0.3 \mu\text{m Pa}^{-1}$  for an area of tube of very approximately  $0.25 \text{ mm}^2$ , this ratio falling with increasing frequency. The long axis of the opening was 1 mm long and the short axis 0.6 mm in length.

#### 4. DISCUSSION

##### (a) *Stimulation of receptor organs*

###### (i) *Lateral line neuromasts*

Stimuli to the neuromasts of the clupeid lateral-line system are of two kinds.

1. Those that are a consequence of liquid flows in the canals arising from the pressure gradients over the surface of the fish acting through the openings of the lateral-line canals to the sea. The mechanics of this kind of stimulation are described by Denton & Gray (1983). The pressure gradients that determine the directions and magnitudes of the flows of liquid in the canals are the net pressure gradients, i.e. when account has been taken of the accelerations of the parts of the surface of the fish in which the lateral line lies. The degree of stimulation depends on the rigidity of the fish in its different parts and in different directions. This is just as true for the flows across the head between the lateral recesses. The subcerebral canal can indeed be regarded, in some respects, as a part of the lateral line system.

2. Those that depend on the flows of liquid through the canal system (particularly parts close to the lateral recesses) that accompany compressions and decompressions of the gas in the auditory bullae caused by pressure changes. Gray (1984) has estimated the magnitudes of such flows when they are produced by symmetrical pressure changes and related these to the neural responses of the neuromasts. The experimental results given here allow us to estimate the neural responses produced by antisymmetrical pressures.

Table 1. *Approximate antisymmetrical pressures required for various effects on lateral line neuromasts*

(For a symmetrical change of pressure the threshold of neuromast 0 is about  $17 \text{ Pa s}^{-1}$  up to 80 Hz, but the main stimulus for all neuromasts is the difference of pressure gradient between water and fish and the threshold is about  $0.25 \text{ Pa m}^{-1}$  (the gradient across the head for the 20 Hz threshold in column 1 is about  $0.8 \text{ Pa m}^{-1}$ ). \*, Based on extrapolations.)

frequency	threshold	neuromast 0 saturation	damage	neuromast 4 threshold
Hz	Pa	Pa	KPa	Pa
1	0.06*	48*	6	0.18*
2	0.03*	24*	3	0.09*
5	0.018*	14*	2	0.05*
10	0.012*	10*	1	0.04*
20	0.008	6	2	0.02
50	0.008	6	2	0.02
100	0.012	10	2	0.04
200	0.01	8	1	0.03

Table 1 gives, for a range of frequencies, the estimated pressure differences across the head of a fish required for threshold and saturation stimulation and for damage to neuromasts 0 and 4. Neuromast 0 is the one nearest the lateral recess and neuromast 4 lies in the horizontal part of the infraorbital canal (see Best & Gray 1980). The pressure differences in table 1 were found in the following way. Absolute velocities of liquid flow in the lateral line were taken from the measurement of particle displacements in the lateral-line canal in the region of neuromast 0 at a frequency of about 3 Hz (see figure 8). Those for higher frequencies were then estimated by multiplying the values obtained at these frequencies by the ratios, found by the reflection method, of the flows at these frequencies to that of the reference frequency (see figure 8). Then using values for threshold velocities in the lateral-line canal for various frequencies (Gray 1984) threshold pressure differences were calculated, column 2 in table 1. The thresholds for the lowest frequencies depend on an extrapolation of a curve given by Gray (1984, figure 8) and they must be viewed with considerable caution.

Gray found that the nerve responses saturated at about 800 times threshold and the values in the third column of table 1 are simply 800 times those in the second column. The values given in the fourth column are estimates of pressure differences likely to damage the neuromasts. These are based on the observation in earlier experiments that velocities of flow in the canals that are greater than  $150 \text{ mm s}^{-1}$  are liable to detach cupulae from neuromasts. The numbers given in the last column of table 1 are based on the finding (Gray & Denton 1979) that when symmetrical pressures are applied to a fish the velocities in the infraorbital canal close to neuromast 4 are a third of those at neuromast 0.

Direct measurements of pressures in the seawater close to a herring making a quick movement (Gray & Denton 1991, figure 6c) indicate pressures of tens of Pascals. When near to the lateral recess such pressures would cause liquid flows in the acoustico-lateralis

system that would stimulate its receptor organs beyond the saturation levels given in table 1. These receptor organs would then be incapable of distinguishing between different intensities of stimulation and so transmit little information. Furthermore, such large self-stimuli would mask any stimuli arising from external sources. It might be that the results given by Gray (1984, figure 5) fail to show the responses of a significant number of small, slow, high threshold fibres. But even if this were true, a major part of the fibre population, including the faster ones, would contribute little information. Another possibility is that the efferent nerves to the receptor organs are effective in controlling the sensitivity of these organs so as to bring their working range into line with the stimuli produced by the fish's own movements. Such movements are, of course, predetermined in the fish's brain. (The role of efferents has been reviewed by Roberts & Meredith (1989).)

For a fish to lose some sensitivity when making a very vigorous turn would not be surprising and, since the fish would already be committed to a decisive action, the temporary loss of sensory information would probably not be one for which the penalty is serious.

A major loss of sensitivity produced by a fish's own movements when swimming continuously in a school would be more serious. In discussing this we have the benefit of the elegant theory given by Lighthill (1993) in the paper that follows this paper. His equations give the pressure across the fish in terms of two components, one related to the yaw and the other to the side-slip of the head. He shows that there could be considerable advantages if a fish could move its head in such a way that these components oppose each other. Further he shows that, for economical swimming the pressure gradients associated with the yawing movements would be out of phase with, and greater in magnitude than, those given by side-slip accelerations. The excess pressure would be sufficient to accelerate the water close to the head so that its movements would follow the movements of the head. This would simultaneously give minimal cross flows within the boundary layer over the head and through the subcerebral canal, returning in effect to the condition shown in figure 1*d*.

From observations on herring (Rowe *et al.* 1993) in a paper following this paper and using Lighthill's equations, we estimate that the side-slip component for a 14 cm herring swimming continuously at about 3 Hz would be about 10 Pa, i.e. a pressure that would largely saturate some of the receptor organs of the acoustico-lateralis system. Rowe *et al.* find, however, by applying Lighthill's theory to their results on herring and to results obtained by Bainbridge (1963) on bream and goldfish and by Videler & Wardle (1978) on cod that, for all four species when swimming continuously, the yaw and side-slip components of pressure do indeed largely cancel each other. An important role of the receptor systems that we are discussing in this paper is likely to be that of providing feedback to regulate the swimming movements to achieve this balance.

likely to be that of providing feedback to regulate the swimming movements to achieve this balance.

Although the anatomical arrangements of the acoustico-lateralis system found in the herring clearly have special merits, a fish could obviously use an entirely superficial lateral-line system to 'measure' antisymmetric pressures without having a canal, similar to the subcerebral canal, running through the head. An efficient arrangement for doing this would be to have lateral-line canals running dorso-ventrally on both sides of the head at positions corresponding to a pivoting position of the head. Such lateral lines would be well placed to monitor flows around the head. Now many species of fish have prominent dorso-ventrally running canals at what would appear to correspond approximately to the position along the length of the fish at which the openings of the herring's lateral recesses are found. We do not know, however, where the pivoting positions lie in these fish, or, indeed, whether they have the kind of swimming movements that could give the relationship between side-slip and yaw which the herring possesses.

In relation to the detection of external stimuli a further conclusion can be drawn. With antisymmetric pressures across the subcerebral canal when the flow in the lateral-line canal is toward the lateral recess on one side it will be away from the lateral recess on the other. Because clupeid neuromasts signal the direction of flow (Lowenstein & Wersäll 1959; Best & Gray 1982) the neuromasts on the two sides will signal opposite polarity. With symmetrical pressures the flow will be either towards on both sides or away on both sides.

Some mention should be made of stimulation of the lateral-line system by pressure gradients over the surface of the fish. The patterns of such stimulation given by external sources and by a fish's swimming movements differ in important respects. Sir James Lighthill has pointed out to us that the pressure distributions over the surface of the head that are produced by a fish's own movements will be mostly determined by accelerations perpendicular to the long axis of the fish. This is because a fish like the herring is very well streamlined for movements along its long axis and not at all well streamlined for movements perpendicular to this axis. As a consequence, at any one instant, the pressures and pressure gradients at corresponding points on the two sides of the head will be equal and opposite. In sharp contrast an external source, unless it is very near, will give fields of pressure over the surfaces of the head which are very similar in magnitude and direction for corresponding positions on the two sides of the head.

(ii) *Maculae of the utricular recess*

Figures 2 and 9 summarize the functional anatomy of the parts of the acoustic-lateralis system involved in the stimulation of the mechanoreceptors of the anterior and middle maculae of the utricle. Just as with the lateral-line neuromasts the maculae can be stimulated both by flows arising from compressions and decompressions of the gas in the bullae and also probably by flows caused by net pressure gradients (in this case across the head) that are independent of the bullae.

*Symmetrical pressure stimuli.* If symmetrical (i.e. identical) pressure changes are applied to both sides of the head, there will be no flows of liquid across the head, the only flows will be into or out of the bullae. On each side of the head the magnitude of such flows will be almost entirely determined by the stiffness of the bulla membrane and the inertance and resistance of the liquid in, and immediately adjacent to, the fenestra. These flows will be divided between branches (a) and (b) of the subcerebral canal (figure 2). Flows into and out of the bulla from branch (a) will not pass across (i.e. by displacing) the anterior and middle maculae and will not stimulate their receptors. Flows along branch (b) will pass into or out of the bulla across the two maculae (figures 2 and 9) in which case the receptors of these macula will respond if the flow is sufficient. At a given frequency the relative contributions of the flows along (a) and (b) to the total flows through the fenestra of the bulla will depend on the relative impedances of the pathway along branch (a) to the fenestra and that along branch (b) and through the maculae to the fenestra.

Experiments by Best & Gray (1980) showed that, with decompressions, the middle macula moved away from the fenestra and at the same time the anterior macula moved forwards, whilst with compressions the maculae moved in the opposite senses. They also showed that as frequency falls below 10 Hz the displacements of the maculae for a given pressure change fall progressively; at 5 Hz to about half that found at frequencies above 10 Hz. Hence it is at these lower frequencies that the impedance given by the stiffnesses of the suspensions of the maculae will become dominant. As frequency rises above 10 Hz, resistances and inertances become progressively more and more important. We calculate from the dimensions of the branches (a) and (b) (see § 4*b*), that, where resistance dominates, about one eighth of the total flow through the fenestra will pass through the maculae. At high frequencies the relative impedances of the two pathways will be mainly decided by their inertances: the ratio of impedances falling from one eighth to about one third. These values are in reasonable accord with the value of about one fifth previously obtained by experiment (Gray & Denton 1979).

*Antisymmetrical pressures.* The experiments described in this paper show that with antisymmetrical pressure changes there will be flows across the head through the subcerebral perilymph canal. At a given frequency the stimuli given to the maculae will, assuming no flow in the endolymph, depend on the relative impedances of the parts of the subcerebral canal. With antisymmetrical pressure stimuli the flows of liquid along the branches (a) and (b) could follow several routes. Some liquid will flow across the head staying within either channel (a) or (b); some will cross the head but pass between (a) and (b) 'across' (i.e. by displacing) the maculae; some will pass along channel (a) and into or out of a bulla and finally some will pass along (b) across the maculae and into or out of a bulla. Only those flows that pass across the maculae have the potential to stimulate their receptors. The

Table 2. *Cumulative percentage increase in inertance and resistance with distance along channels (a) and (b) of the subcerebral canal*

Distance from midline $\mu\text{m}$	cumulative percentage increase			
	channel (a)		channel (b)	
	inertance	resistance	inertance	resistance
420	10.6	8.8	9.0	5.8
480	22.0	19.0	20.0	14.6
540	36.8	36.3	34.0	29.7
600	49.6	49.3	51.0	51.4
660	64.4	66.6	68.0	73.2
720	77.5	80.1	82.0	87.3
780	89.0	89.0	94.0	97.2
840	100.0	100.0	100.0	100.0

flow across the utricular recess between channels (a) and (b) will depend on the pressure drops along the channels. Table 2 gives the percentage fall in pressure occurring at each distance along the channels both for resistive impedances and for inertive impedances.

These are relative values calculated from the areas of the channels (figure 10). The percentage falls for corresponding distances along the channels are remarkably similar for both channels, i.e. at any particular distance from the bifurcation the pressure will be approximately equal on the two sides; any differences are well within the errors of estimation. Furthermore the maculae take up a considerable length of each channel and may not be displaced uniformly. We cannot at present predict the magnitude or even direction of any flow across the maculae, but two conclusions can be reached. First, because the impedance of channel (b) is large any flows through the maculae will be small. They could, however, be significant. Second, and perhaps more important, if it is assumed that the system under discussion has the same properties on the two sides of the head, the magnitudes and the polarities of any stimulation will be equal and opposite on the two sides of the fish. This is unlike the stimulation given by symmetrical pressure changes when the polarities of stimulation on the two sides will be the same.

Another possibility which must be borne in mind is that, if there is a passage of sufficiently low impedance out of the endolymph, part of the flow across the head could pass simultaneously from both channels (a) and (b) across both utricular maculae into the utricular recess. Antisymmetric flows passing by this route would cause the two maculae to move either towards or away from each other unlike other situations with both antisymmetric and symmetric pressure changes.

(iii) *The otolith organs*

Some mention should be made of the otolith organs. Over the frequency range 0–100 Hz, we should expect that the stimulation of the mechanoreceptors depending, as it does, on the inertia of otoliths would be the same for accelerations of the head given by a fish's own movements as for those produced by an external source. In other fish it has been shown that the thresholds to the acceleration of the head along the



rostral-caudal axis change very little with frequency below 100 Hz at least down to a fraction of one Hz (Chapman & Sand 1974; Karlsen 1992).

In the herring the orientations of the hair cells show that all the otolith organs, including those hair cells related to the utricular otolith (Popper & Platt 1979), are most sensitive to accelerations in a plane vertical to the long axis of the fish (Sand 1974). In clupeids this is in sharp contrast to those receptor units which respond to flows through the subcerebral canal which are maximal for accelerations across the head and minimal with accelerations along the long axis of the fish. In the clupeids there are two other interesting points: (i) a small fraction of any flows across the head will pass alongside the saccular macula and through the channel which Tracy (1920) calls the saccular subcerebral canal; (ii) there are also probably flows which are significant at high frequencies in the dorso-ventral axis, which depend on pressure changes causing liquid to flow through the auditory foramina into and out of the auditory bullae (Gray & Denton 1979). These flows could excite receptors more usually responding to vertical accelerations acting through the otoliths.

### (b) Models of the system

We have complemented the experimental work by making mathematical models of the system. The well known equations for electrical impedance networks were used on the hydrodynamic impedance network of the acoustico-lateralis system. The hydrodynamic quantities used (with their electrical analogues in brackets) were: (i) flow,  $\text{m}^3 \text{s}^{-1}$  (current); (ii) pressure, Pa (potential); (iii) stiffness,  $\text{Pa m}^{-3}$  (the reciprocal of capacitance); (iv) resistance,  $\text{Pa m}^{-3} \text{s}^{-1}$  (resistance); (v) inertance,  $\text{Pa m}^{-3} \text{s}^{-2}$  (inductance).

In the next section we consider how values of the components of the networks were calculated from physical dimensions and other evidence. We then discuss particular networks and compare the results of calculations with the experimental results.

#### (i) The values of the components

By making appropriate corrections the values found for the various components on several fish which differed from each other in length, were made to relate to a fish of 10 cm length. The most complete network considered is given in figure 11a. This

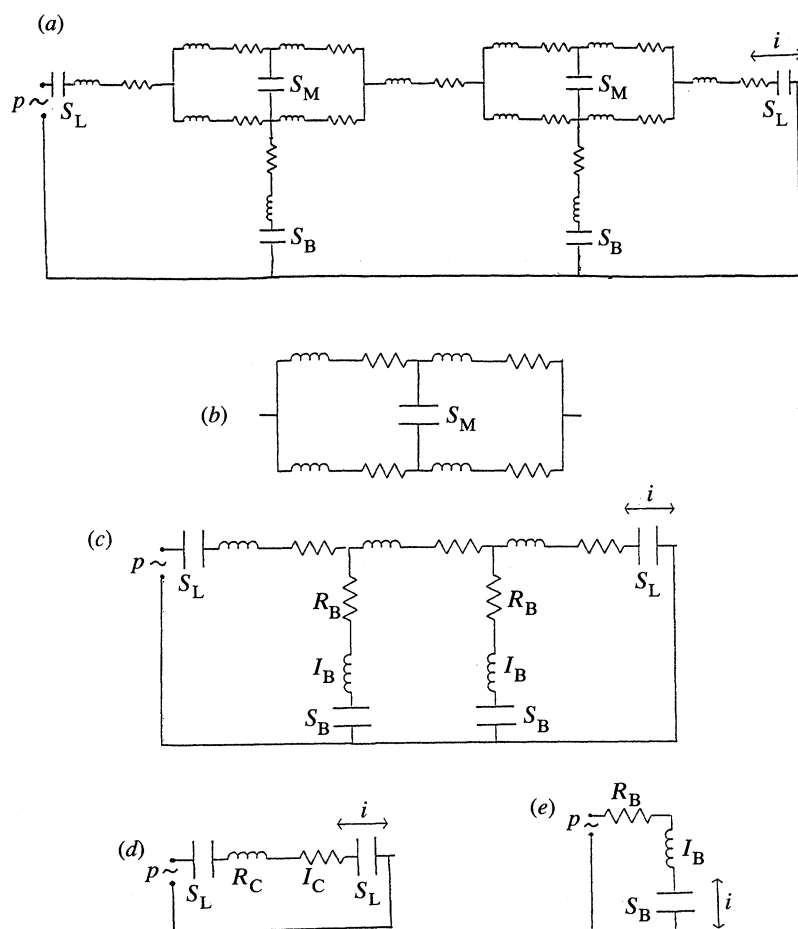

Figure 11. Equivalent circuits with electrical symbols suggested by anatomy. (a) Whole circuit. (b) Circuit representing the utricular recess and channels (a) and (b). (c) A simplification of (a) used for calculations (see text). (d) An even more simplified circuit likely to be applicable at low frequencies, below 30 Hz, for asymmetric pressures. (e) Equivalent circuit for the bulla for symmetric pressures.  $S_L$  is stiffness of lateral-recess membrane,  $S_B$  stiffness of bulla membrane,  $S_M$  stiffness of maculae of utricular recess,  $R_C$  and  $I_C$  are the resistance and inertance of the subcerebral canal and  $R_B$  and  $I_B$  the resistance and inertance of the bulla circuit (see text and table 3).



network was suggested by the anatomy of the system and some earlier observations.

**Stiffnesses.** Measurements of membrane area and of the displacements of the centre of the bulla membrane in response to changes in pressure (Denton & Blaxter 1976) enabled calculation of volume displacements and hence stiffnesses, (pressures to give unit volume displacements) of the bulla membranes together with the gas in the bullae.

The stiffnesses of lateral-recess membranes were estimated from measurements of the displacement of particles in the lateral-line canal in response to sinusoidal pressure changes of low frequency (a few Hz) across the head (figure 4). From these results volume displacements for known pressure changes can be found. These estimates of stiffness are based on the assumption that at these frequencies, where displacements for given pressure changes are almost independent of frequency, the only impedance across the head is given by the lateral recess membranes. The bulla membranes are known to be very much stiffer than the lateral recess membranes and at lower (less than 30 Hz) frequencies the impedance associated with the bulla is so high that the network given in figure 11*a* can be simplified to that in figure 11*d*.

**Resistances.** Resistances were calculated from the dimensions of the various channels adding together the calculated resistances of 'elements' of channels. A complication lies in the fact that the hydrodynamic resistance of a tube varies with frequency. This is because the flow pattern across a tube, and hence the frictional force against the wall of the tube for a given average velocity of flow, will vary with frequency.

In this paper we have assumed that resistance is constant up to the frequency for which the quantity  $k=4$  where  $k=r\sqrt{(\omega/\nu)}$  ( $\nu$  is the kinematic viscosity,  $\omega$  is  $2\pi$  times frequency and  $r$  is the radius of the tube). For these frequencies we have assumed that resistance can be calculated from Poiseuille's equation, the resistance of a tube of length ( $l$ ) and cross-sectional area ( $A$ ) being  $8\pi\eta l/A^2$  where  $\eta$  is viscosity of perilymph at 14°C, taken here to be  $1.4 \times 10^{-3}$  Pa.s (see Wilson & Melvill Jones 1979, table 2-1). Where  $k$  exceeded 4 we assumed that the resistance increased as the square root of frequency. These approximations are based on information given by Schlichting (1968). In some cases where an 'element' of a channel was particularly narrow and short we have allowed for an 'end effect' (see Kinsler & Frey 1962). As resistance is inversely proportional to area squared accurate measurements of the narrower of the channels are very necessary if errors are to be minimized. It is in such 'elements' that the assumption of circular cross sections will be most serious; non-circularity leading to underestimation of resistance.

The resistance of the whole subcerebral canal estimated from experiments for a 10 cm herring is equivalent to a tube the length of the width of the head (7 mm) having a cross-sectional area of 0.04 mm<sup>2</sup>. The corresponding cross-sectional area for a 17 cm red mullet was 0.05 mm<sup>2</sup>.

**Inertances.** The inertance of liquid in a tube is given by the mass of the liquid in the tube divided by the

square of the cross sectional area of the tube. The inertances were, like the resistances, estimated from the dimensions of the various channels. Where a channel varied in cross section the inertance of each 'element' was taken as the mass of liquid it contained divided by its cross-sectional area ( $A$ ) squared. Because the mass of the liquid in an 'element' is itself proportional to  $A$ , a given 'element' will make a contribution to the total inertance which is proportional to its length and inversely proportional to  $A$ . A narrow constriction can have a large effect.

#### (ii) Models

Direct measurements of flow at the lateral recess made it possible to estimate thresholds for the lateral-line canal neuromasts. Any understanding, however, of the differences in excitation of the maculae of the utricular recess to antisymmetric and symmetric pressures requires more knowledge of the impedance network within the head. To this end analyses were made both of experimental results and models in terms of impedance networks. Analyses of early results soon showed that the flow-frequency characteristics observed could not be represented in terms of a simple damped oscillator. It was therefore decided to construct a more complete model based on the anatomy. The equivalent circuit developed on this basis is shown in figure 11*a*. The division of flow around the utricular recess (figure 11*b*) has been discussed in the section on the maculae of the utricular recess and illustrated in figure 10 and table 2. For purposes of relating the measured flow ( $i$ , figure 11) at one lateral recess to the alternating pressure applied to the other ( $p$ , figure 11) a number of the impedances can be combined and the circuit reduced to that in figure 11*c*. Using ranges of values around those given in table 3 it was found that this model could not explain all the results.

The model tested could never, whatever values of the parameters were used, reproduce the higher frequency peak seen in the experiments (figure 8). However, calculations showed that a good match could be obtained by placing a circuit with a higher stiffness and lower inertance than  $S_L$  and  $I_C$  (figure 11*d*) in parallel with the elements representing the subcerebral canal in figure 11*c*. The complex anatomy shows that there are a number of pathways which run parallel across the head and could alone or together, if the impedances were right, contribute to such a result, e.g. into and out of the labyrinth on either side, across the central membranous partition, across the dura and CSF and perhaps most interesting across the utricular maculae into the endolymph and out across the wall of the labyrinth. However, the agreement at low frequencies was sufficiently encouraging for us to use a simpler model to analyse the results at these frequencies. At these low frequencies the reactance of the bulla membrane is so high that the circuit can be reduced to that in figure 11*d*. Before considering this simple model we turn to a reassessment of the results of Denton *et al.* (1979) on sprat as a test of the method.

The relevant quantities for what we may describe as the bulla circuit of the sprat (figure 11*e*) are given in

Table 3. *Components of impedance networks*(The symbols  $S$ ,  $I$  and  $R$  are used in figure 11.)

	from experiment	from dimensions
herring		
lateral recess membrane (each)		
stiffness ( $S_L$ )	$2.0 \times 10^{12} \text{ Pa m}^{-3}$	
subcerebral canal (total)		
inertance ( $I_C$ )	$1.6 \times 10^8$	$8.0 \times 10^7 \text{ Pa}/(\text{m}^3 \text{ s}^{-2})$
resistance ( $R_C$ )	$1 \times 10^{11}$	$4.5 \times 10^{10} \text{ Pa}/(\text{m}^3 \text{ s}^{-1})$
frequency for resistance change	16 Hz	
bullae (each)		
stiffness ( $S_B$ )	$2.70 \times 10^{14} \text{ Pa m}^{-3}$	
inertance ( $I_B$ )		$1.0 \times 10^7 \text{ Pa}/(\text{m}^3 \text{ s}^{-2})$
resistance ( $R_C$ )		$5.6 \times 10^9 \text{ Pa}/(\text{m}^3 \text{ s}^{-1})$
frequency for resistance change		12 Hz
sprat		
bullae (each)		
stiffness	$3.0 \times 10^{14} \text{ Pa m}^{-3}$	
inertance		$2.7 \times 10^7 \text{ Pa}/(\text{m}^3 \text{ s}^{-2})$
resistance		$4.1 \times 10^{10} \text{ Pa}/(\text{m}^3 \text{ s}^{-1})$
frequency for resistance change		400 Hz

the bullae circuit of the sprat (figure 11*e*) are given in table 3. From the values of  $3 \times 10^{14} \text{ Pa m}^{-3}$  for stiffness (based on direct measurements) and of inertance (estimated from dimensions) we arrive at an estimated resonant frequency of 530 Hz which is close to that found by experiment (see figures 7 and 8 of Denton *et al.* (1979)). The estimate of resistance at 530 Hz obtained from dimensions is about one-quarter of the critical resistance and close to the value expected from the experimental results. We have less good experimental data for the herring. The resonant frequency calculated from the data of table 3 is about 830 Hz whilst the data we have (see Denton *et al.* 1979, figure 13*b*; Blaxter *et al.* 1981, figures 2–6*b*) indicates a lower value. These are drawn from studies of nervous activity and behaviour and not from the actual physical behaviour of the peripheral components. If the true value of the resonance was about 600 Hz (a value deduced from Enger's (1967) results (see Denton *et al.* 1979)) the value of the inertance estimated from dimensions would be about half of the true value. The value of resistance calculated for 830 Hz from dimensions is about one-half of the critical value. This is probably lower than the true value.

Let us now turn to the simple model (figure 11*d*) and its relation to the experimental results. The procedure adopted was to obtain the main parameters from the experimental results themselves, see if the resulting flow or displacement relation to frequency is a reasonable fit to the experimental points and then to compare the parameters used with the corresponding values obtained from dimensions. Values for resonant frequency and damping can be obtained from the results. Knowing the stiffness of the lateral recess membranes the inertance can be calculated from the equation  $f_n = \frac{1}{2\pi} \sqrt{S/I}$ , where  $f_n$  is the resonant frequency,  $S$  the stiffness and  $I$  the inertance. In an electrical circuit of the kind shown in figure 11*d*

current peaks at the resonant frequency and the phase shift is  $90^\circ$ . In some hydrodynamic networks such as the one described resistance is a function of frequency (see above). This means that resonance, the frequency at which the reactance of the stiffness is equal to the reactance of the inertance and which is indicated by the phase shift of  $90^\circ$  is not the frequency at which flow velocity peaks. The declining resistance as frequency falls shifts the peak to a lower frequency. Knowing the stiffness and inertance the resistance at  $f_n$  could be found from the ratio of the amplitude of displacement at  $f_n$  to that at zero frequency. The resistance was assumed to increase as the square root of frequency above a particular frequency (see § 4*b*(i) 'Resistance'); the value of this frequency for resistance change was found by trial and error. The best fit was obtained with the values in the second column of table 3 which derive from a particular experiment and this curve is plotted together with the points of the same experiment in figure 6. Below 30 Hz the results are consistent with this model. These values on which the curve was based are about twice those estimated from the dimensions of the various channels. However, considering that they were obtained for different fish and depend very much on the value of the stiffness of the very compliant lateral-recess membrane, the agreement is sufficiently good to make us think that the estimates based on dimensions can be useful and they are used above in relation to the utricular recess.

### (c) *Some general considerations*

We shall end the discussion by reconsidering the questions posed in the introduction.

1. A striking finding of the experiments described above is that the stimuli given to neuromasts of the lateral-line system by self-generated pressures are

made, by flows through the subcerebral canal, much larger than the stimuli given by comparable pressures produced by external sources. For reasons discussed above one function among others of these receptor organs is, almost certainly, to provide information that allows the fish to swim in such a way that these flows are minimized so that the receptor organs can still be useful in the detection of external sources of vibrations and at the same time swim more economically. This could, in general, mean that fish might use pressures and pressure gradients in the water, rather than, or as a complement to, the forces within muscles and tendons, to regulate muscular activity. (In our own bodies these forces are monitored by stretch and tendon receptors (with higher control from the labyrinth) so allowing posture to be maintained against gravitational forces.)

2. Although the hydrodynamic actions on the lateral-line and utricular receptor organs which are produced by a fish's own movements and by external sources must sum, there are great differences in the patterns of stimuli which they give. The antisymmetric stimuli from a fishes own movements will be equal and opposite for corresponding receptors on the left and right sides of the head, e.g. for corresponding hair cells of particular neuromasts. In contrast, the stimuli given by external sources will always have the same polarity. In relation to such patterns of stimulation a special problem exists with respect to self-generated stimulation of the anterior and middle maculae of the utricle. There are several possibilities. In one of these the actions of the cross-head flows on the utricular maculae could balance those of the flows into the bullae so diminishing, or even abolishing, the stimuli to the maculae and making the detection of external sources easier. In another, which supposes there are flows along the utricular recesses, the anterior and middle maculae would be driven in opposing directions so producing another qualitative difference between the two classes of stimuli. We need more information on the detailed mechanics of this system before we can decide between such possibilities.

3. The present results, together with those in the two, papers that immediately follow this one, indicate that, even if the receptors are to a great extent protected there are probably times when self-generated pressures mask the detection of external sources. However, if a neighbouring fish in a school makes a quick movement the chances of detecting it will be better than might be supposed. This is, because a sudden movement will not only produce a signal which is greater in amplitude than normal swimming movements but also because it would give a signal richer in higher frequency components. Now the pressures and pressure gradients produced by a movement of a given amplitude are proportional to frequency squared and the sensitivities of some of the receptor organs rise with frequency. Sometimes these factors together give a frequency cubed or better advantage in ease of detection of the faster movements. However, a more difficult problem remains with respect to one fish in a school monitoring the activities of neighbours when they are all making

closely similar swimming movements. The observations made by Moulton (1960) show that one clupeoid can do this, at least when schooling actively. He placed one blinded *Anchoviella* with 12 normal fish. The blind fish did not pay any attention to the group until the group was startled by a hand movement. It then immediately joined the group and streamed and veered with the group. Comparable findings on a non-clupeoid were made by Pitcher *et al.* (1976) who showed that saithe blinded by placing opaque cups over the eyes could school and that the body lateral line was essential to their being able to do this.

4. In general with respect to masking we need information of several kinds including: (i) the ways in which the location of the receptor organs improves the balance between the stimuli given by external sources and by the fishes own movements; (ii) the effects of combining background (conditioning) and signal (test) stimuli found in a study of receptor potentials in the utricle (Denton & Gray 1980); (iii) the effects of the specialization of these organs to deal with transients rather than tones.

5. Whether or not physical additions and subtractions of pressures and pressure gradients cause the pattern of activity between receptors and receptor organs to change in such a way that purposeful interactions take place more efficiently, e.g. with more accurate resolution of the time relations or more quickly or with less central processing, is a question that cannot be answered until we know three things: (i) that the components added or subtracted are of comparable size and the total stimulation is within the working range of the receptor organ; (ii) that the receptor units in the population are the same and not merely near neighbours; and (iii) that specific cases can be calculated with known external pressure fields related to particular response patterns.

The authors are Honorary Fellows of the Marine Biological Association of the United Kingdom and are very grateful to the M.B.A. and its Director, Dr M. Whitfield, for providing accommodation and facilities for this work. One of us (E.J.D.) received generous research grant support from the Natural Environment Research Council. We are particularly grateful to Sir James Lighthill F.R.S. for advice. We thank Dr Q. Bone and Dr R. Williamson for critical discussion of the manuscript and the Dunstaffnage Marine Laboratory which generously provided the herring used in these experiments.

## REFERENCES

- Allen, Jennifer M., Blaxter, J.H.S. & Denton, E.J. 1976 The functional anatomy and development of the swim-bladder-inner ear-lateral line system in herring and sprat. *J. mar. biol. Ass. U.K.* **56**, 471–486.
- Bainbridge, R. 1963 Caudal fin and body movement in the propulsion of some fish. *J. exp. Biol.* **40**, 23–56.
- Best, A.C.G. 1979 A stereoscopic method of viewing internal structures in resin-embedded biological specimens. *J. Microsc.* **116**, 271–274.
- Best, A.C.G. & Gray, J.A.B. 1980 Morphology of the utricular recess in the sprat. *J. mar. biol. Ass. U.K.* **60**, 703–715.
- Best, A.C.G. & Gray, J.A.B. 1982 Nerve fibre and receptor



- counts in the sprat utricle and lateral line. *J. mar. biol. Ass. U.K.* **62**, 201–213.
- Blaxter, J.H.S. & Batty, R.S. 1985 Herring behaviour in the dark: responses to responses to stationary and continuously vibrating obstacles. *J. mar. biol. Ass. U.K.* **65**, 1031–1049.
- Blaxter, J.H.S., Denton, E.J. & Gray, J.A.B. 1981 Acoustico-lateralis system in clupeoid fishes. In *Hearing and sound communication in fishes* (ed. W. N. Tavolga *et al.*), pp. 39–59. New York: Springer-Verlag.
- Blaxter, J.H.S. & Fuiman, L.A. 1990 The role of the sensory system of herring larvae in evading predatory fishes. *J. mar. biol. Ass. U.K.* **70**, 413–428.
- Chapman, C.J. & Sand, O. 1974 Field studies of hearing in two species of flat fish, *Pleuronectes platessa* (L) and *Limanda limanda* (L) (family Pleuronectidae). *Comp. Biochem. Physiol.* **47A**, 371–385.
- Denton, E.J. & Blaxter, J.H.S. 1976 Function of the swimbladder–inner ear–lateral line system of herring in the young stages. *J. mar. biol. Ass. U.K.* **56**, 487–502.
- Denton, E.J. & Gray, J.A.B. 1980 Receptor activity in the utricle of the sprat. *J. mar. biol. Ass. U.K.* **60**, 717–740.
- Denton, E.J. & Gray, J.A.B. 1983 Mechanical factors in the excitation of clupeid lateral lines. *Proc. R. Soc. Lond. B* **218**, 1–26.
- Denton, E.J. & Gray, J.A.B. 1989 Some observations on forces acting on neuromasts in fish lateral line canals. In *The mechanosensory lateral line: neurobiology and evolution* (ed. S. Coombs *et al.*), pp. 229–246. New York: Springer-Verlag.
- Denton, E.J., Gray, J.A.B. & Blaxter, J.H.S. 1979 The mechanics of the clupeid acoustico-lateralis system: frequency responses. *J. mar. biol. Ass. U.K.* **59**, 27–47.
- Du Bois, A.B., Cavagna, G.A. & Fox, R.S. 1974 Pressure distribution on the body surface of swimming fish. *J. exp. Biol.* **60**, 581–591.
- Enger, P.S. 1967 Hearing in herring. *Comp. Biochem. Physiol.* **22**, 527–538.
- Enger, P.S., Kalmijn, A.J. & Sand, O. 1989 Behavioural investigations on the function of the lateral line and inner ear in predation. In *The mechanosensory lateral line: neurobiology and evolution* (ed. S. Coombs *et al.*), pp. 575–587. New York: Springer-Verlag.
- Gray, J.A.B. 1984 Interaction of sound pressure and particle acceleration in the excitation of the lateral-line neuromasts of sprats. *Proc. R. Soc. Lond. B* **220**, 299–325.
- Gray, J.A.B. & Denton, E.J. 1979 The mechanics of the clupeid acoustico-lateralis system: low frequency measurements. *J. mar. biol. Ass. U.K.* **59**, 11–26.
- Gray, J.A.B. & Denton, E.J. 1991 Fast pressure pulses and communication between fish. *J. mar. biol. Ass. U.K.* **71**, 83–106.
- Hassan, E.S. 1989 Hydrodynamic imaging of the surroundings by the lateral line of the blind cave fish *Anoptichthys jordani*. In *The mechanosensory lateral line: neurobiology and evolution* (ed. S. Coombs *et al.*), pp. 217–227. New York: Springer-Verlag.
- Karlsen, H.E. 1992 Infrasound sensitivity in the plaice (*Pleuronectes platessa*). *J. exp. Biol.* **171**, 173–187.
- Kinsler & Frey 1962 *Fundamentals of acoustics*. (524 pages.) New York: John Wiley.
- Lowenstein, O. & Wersäll, J. 1959 A functional interpretation of the electron-microscopic structure of the sensory hairs of the cristae of the elasmobranch *Raja clavata* in terms of directional sensitivity. *Nature, Lond.* **184**, 1807–1808.
- Lighthill, J. 1993 Estimates of pressure differences across the head of a swimming clupeid fish. *Phil. Trans. R. Soc. Lond. B* **341**, 129–140. (Following paper.)
- Montgomery, J.C. 1989 Lateral line detection of planktonic prey. In *The mechanosensory lateral line: neurobiology and evolution* (ed. S. Coombs *et al.*), pp. 561–574. New York: Springer-Verlag.
- Moulton, J.M. 1960 Swimming sounds and the schooling of fish. *Biol. Bull. mar. biol. Lab., Woods Hole* **119**, 210–223.
- Pitcher, T.J., Partridge, B.L. & Wardle, C.S. 1976 A blind fish can school. *Science, Wash.* **194**, 963–965.
- Popper, A.N. & Platt, C. 1979 The herring ear has a unique receptor pattern. *Nature, Lond.* **280**, 832–833.
- Roberts, B. & Meredith, G. 1989 The efferent system. In *The mechanosensory lateral line: neurobiology and evolution* (ed. S. Coombs *et al.*), pp. 445–459. New York: Springer-Verlag.
- Rowe, D.M., Denton, E.J. & Batty, R.S. 1993 Head turning in herring and some other fish. *Phil. Trans. R. Soc. Lond. B* **341**, 141–148. (This volume.)
- Sand, O. 1974 Directional sensitivity of microphonic potentials from the perch ear. *J. exp. Biol.* **60**, 881–899.
- Schlichting, H. 1968 *Boundary layer theory* (pp. 419–421). New York: McGraw-Hill.
- Tracy, H.C. 1920 The membranous labyrinth and its relation to the pre-coelomic diverticulum of the swim bladder in clupeids. *J. comp. Neurol.* **31**, 219–31257.
- Videler, J.J. & Wardle, C.S. 1978 New kinematic data from high speed cine film recordings of swimming cod (*Gadus morhua*). *Netherl. J. Zool.* **28**, 465–484.
- Weissert, R. & von Campenhausen, C. 1981 Discrimination between stationary objects by the blind cave fish *Anoptichthys jordani* (Characidae). *J. comp. Physiol. A.* **143**, 375–381.
- Wilson, J. & Melvill Jones, G. 1979 *Mammalian vestibular physiology*. (365 pages.) New York: Plenum Press.

Received 17 September 1992; revised and accepted 10 February 1993